

143 mm

210 mm

DCH90B/DCH90SS  
COOKERHOOD



Believe in better



Customer Care Line  
(after sales service)

086 100 3339

Version No.  
01M-9210003600-3623-03 / 01M-9210013600-3623-03

Cooking  
Instruction manual



## **Index**

- 2** Introduction
- 2** Unpacking
- 3** Important safety instructions
- 5** Package information
- 6** Electrical connection
- 7** Parts
- 7** Installation instructions
- 8** Installation requirements
- 9** Air outlet installation
- 11** Control panel
- 12** Maintenance
- 13** Technical specifications
- 14** Troubleshooting
- 15** Customer care
- 16** Warranty

## **Introduction**

Congratulations on the purchase of this quality cooker hood. We, trust that you will enjoy many years of trouble free use. Please read these instructions carefully before using the cooker hood.

This book will provide you with information on how to operate and care for your cooker hood in order that you gain the maximum benefit from it.

## **Unpacking**

- Please ensure that packaging material is disposed of in a responsible manner.
- Plastic bags should be cut up to prevent children playing with them and accidentally suffocating.
- Some models feature a protective film over the stainless steel. This film must be carefully removed before using the cooker hood.
- If the appliance is damaged in any way, do not use it. Report the damage to your dealer, who will take the necessary corrective action.

Please register your product at [\*\*www.defy.co.za\*\*](http://www.defy.co.za)

## Important safety instructions

This section contains safety instructions that will help you avoid risk of injury and damage. All warranties will be void if you do not follow these instructions.

This appliance is intended to be used in household and similar applications such as:

1. Staff kitchen areas, in shops, offices and other working environments
2. Farm houses;
3. By clients in hotels, motels and other residential type environments;
4. Bed and breakfast type environments

### General safety

- This cooker hood is not intended for use by persons (including children) with reduced physical, sensory or mental capabilities or lack of experience and knowledge, unless they have been given supervision or instruction concerning the use of the cooker hood by a person responsible for their safety.
- Children must be supervised to prevent them from tampering with the cooker hood.
- Cleaning and user maintenance must not be done by children without supervision.
- Do not operate the cooker hood if it is defective or has any visible damage.
- Do not carry out any repairs or modifications on the cooker hood.
- Never wash down the cooker hood with water! There is a risk of electric shock!
- Never use the cooker hood when your judgment or coordination is impaired by the use of alcohol and/or drugs.
- The cooker hood must be disconnected from the mains during installation, maintenance, cleaning and repair procedures.
- Do not place any flammable materials close to the cooker hood.
- Make sure that the cooker hood function knobs are switched off after every use.
- Switch off the power at the mains in the event of a fault or when cleaning the cooker hood.
- Do not check the status of the filters while the cooker hood is operating.
- Never operate the cooker hood without a filter.
- This cooker hood complies with all relevant safety regulations.

- Never leave cooking fat or oil unattended. Overheated fat or oil can easily catch fire.
- Do not flambé food directly under the cooker hood. The flames pose the risk of the filter catching fire.
- Restrictions apply to the use of the cooker hood over a solid fuel or gas stove.
- Observe the minimum distance between the supporting surface for cooking vessels on the hob and the lowest part of the cooker hood. (When the cooker hood is located above a gas appliance, this distance shall be at least 65 cm).
- Regulations concerning the discharge of air must be fulfilled.
- The air must not be discharged into a flue that is used for exhausting fumes from appliances burning gas or other fuels.
- There must be adequate ventilation of the room when the cooker hood is used at the same time as appliances burning gas or other fuels.
- Do not touch any part of the light fittings or adjacent areas during or straight after prolonged use as they get very hot and could cause severe burns.
- In certain circumstances electrical appliances may be a hazard.
- Avoid leaving exposed flames unattended and always ensure that the burners are covered as open flames are damaging for the filters and a fire hazard.
- Constantly check food frying to avoid overheated oil becoming a fire hazard.
- Use a damp cloth and neutral soap to clean the cooker hood after the specified time (suggestion: every 2 months), and keep the unit from danger of burning. There is a fire risk if cleaning is not carried out in accordance with the instructions.
- Do not use with a programmer, timer, separate remote-control system or any other device that switches on automatically.



**CAUTION:** Accessible parts may become hot when used with cooking appliances.

### Safety for children

- Electrical products are dangerous to children. Keep children away from the cooker hood when it is operating and do not allow them to play with the cooker hood.
- Packaging materials are dangerous for children. Keep packaging materials away from children. Please dispose of all parts of the packaging in a responsible manner.
- Plastic bags should be cut up to prevent children playing with them and accidentally suffocating.

## Safety when working with electricity



- Connect the cooker hood to an earthed outlet/line protected by a fuse of suitable capacity. Have the earth installation made by a qualified electrician. This cooker hood must be earthed and the manufacturer and the seller do not accept responsibility for any damage due to incorrect installation or electrical connection.
- If the supply cord is damaged, it must be replaced by the manufacturer, its service agent or similarly qualified persons in order to avoid a hazard.
- Defective electric equipment is one of the major causes of house fires.
- Work on electrical equipment and systems must only be carried out by authorized and qualified persons.
- In case of any damage, switch off the cooker hood and disconnect it from the mains. Report the damage to your dealer, who will take the necessary corrective action.



## Package information

- Do not dispose of the packaging materials together with domestic or other wastes. Take them to collection points designated by the local authorities.

## Future Transportation

- Keep the product's original carton and transport the product in it. Follow the instructions on the carton. If you do not have the original carton, pack the product in bubble wrap or thick cardboard and tape it securely.

 	<p>Danger of fire: Do not store items on the cooking surface.</p> <p><b>CAUTION:</b> The cooking process has to be supervised. A short term cooking process has to be supervised continuously.</p> <p><b>WARNING:</b> Unattended cooking on a hob with fat or oil can be dangerous and may result in a fire.</p>
--	--

	<p><b>Warning:</b> The manufacturer shall not be liable for any damage caused by improper use or handling errors.</p>
	<p><b>Warning:</b> Damaged power cables must be replaced by an Authorized Service Agent.</p>

## Electrical connection

- The cooker hood uses a 220-240V~, 50/60Hz power supply.
  - If the mains power cord is damaged, it must be replaced by a qualified electrician.
  - The cooker hood must be earthed. The manufacturer and the seller do not accept responsibility for any damage due to incorrect electrical connection.
  - This cooker hood may not be used with a battery inverter power supply.
- Lamp type:L14(AC:110-240V);
  - Shape description: square ;
  - Rated wattage of the intended lamp: 2W;
  - Max wattage of a potential replacement lamp: 2W;
  - Rated voltage or voltage range of lamp : AC:110-240V;
  - Nominal dimension of lamp: 34.5x120mm

## Description

- The cooker hood fan extracts the kitchen vapours and passes them through the filter.
- The filter absorbs the solid particles in the cooking vapours, keeping the kitchen almost free of grease.

## Before use

Before using your new cooker hood for the first time, please read this manual carefully. It contains important information concerning your personal safety as well as on the use and care of the cooker hood.

- Remove all packaging (except any protective film on the cooker hood if applicable) and dispose of it in an environmentally friendly manner.
- If the cooker hood is damaged in any way, do not use it. Report the damage to your dealer, who will take the necessary corrective action.

	<b>Note:</b> Ensure any protective coverings have been removed after installation.
--	--

## Mode of operation

The appliance has been designed as either an air extractor (The air is drawn in and cleaned by the aluminium filter and directed outside through an exhaust pipe with 120mm diameter (not included with the product) or as an air re-circulator (The air is drawn in and cleaned by a carbon filter).

## Parts

### Core Unit

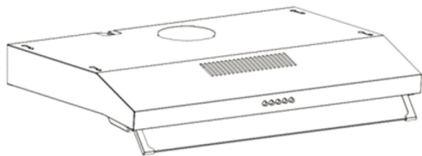

Air Outlet



Dampers



Vent cover



St4 × 30



φ 5 × φ 8

### Tools required



Pencil



Measuring tape

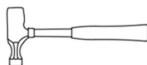

Hammer

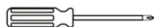

Screwdriver



Level



Drill

### Installation instructions

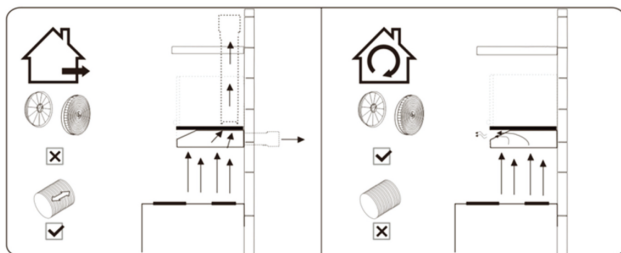

Ducted option

Recirculation option

- If you have an outlet to the outside, your cooker hood can be connected as above by means of a pipe (with an interior diameter of 120mm).
- If you do not have an outlet to the outside, use the recirculation mode by making use of a carbon filter.



## Installation requirements

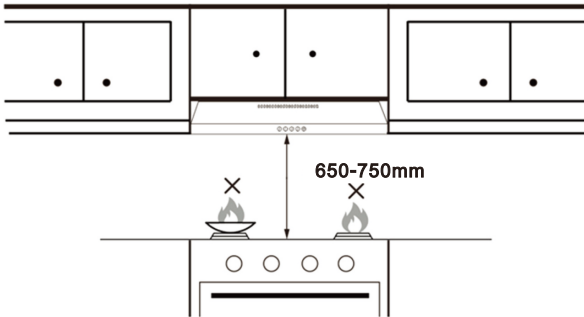

The cooker hood should be placed at a distance of 650~750mm above the cooktop for the best effect.

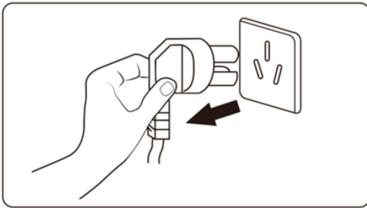
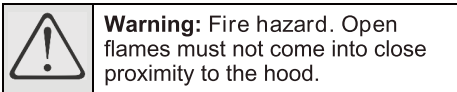

- Before installation, switch the unit off and unplug it from the outlet.

## Air Outlet Installation Method

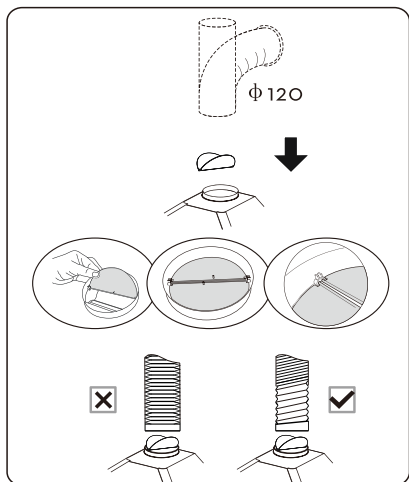

### Installation method for 120mm diameter pipe:

insert the one-way-valve as per the diagram and fix the pipe.

The pipe near the air outlet must be fully extended.



**Attention!** The raised part of the one way valve must face upwards.

## Installation

### Cabinet only

Mark up the position and drill 4 holes of 6mm diameter into the bottom of the cabinet. Cut the vent hole in cabinet.

Align the cooker hood with the hole in the bottom of the cabinet and fasten in with the 4 off ST4×30 screws as per the diagram.

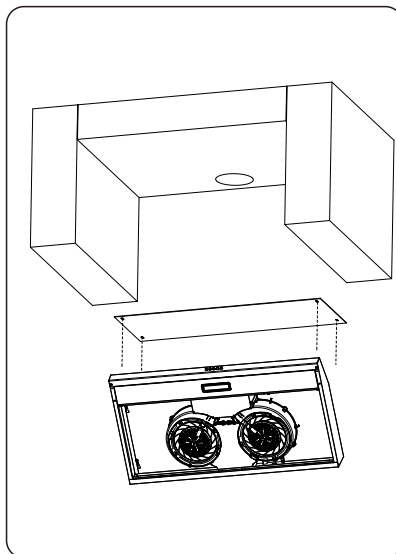

## Air ventilation setting

### Outdoor exhausting:

Switch the adjuster to the outdoor position. Install the outlet, switch on the cooker hood and the air will be vented from the outside outlet.

### Recycling:

To use the recycling mode with carbon filter, switch the adjuster to the indoor position. Install the outlet cover, switch on the cooker hood and the air will be vented from the inside outlet.

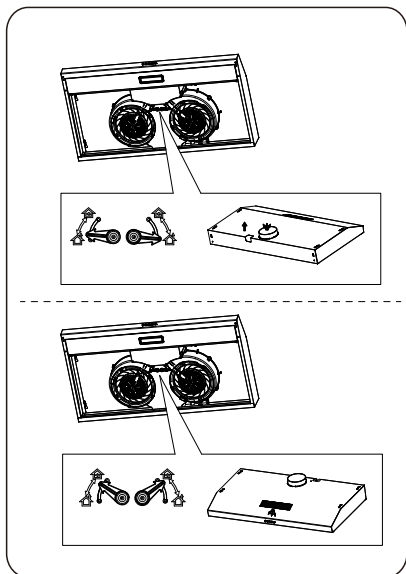

**Warning:** The charcoal cannot be washed or recycled. It should be changed at most after 120 hours using. The carbon filter shouldn't be exposed to heat.



**Caution:** Please remove the white/blue protective film on the range hood before use

## Control panel

### Push button



0

#### **OFF Button**

Turn off the fan.

1

#### **Low Speed Button**

Start the fan at low speed .

It is suitable for simmering and cooking which does not make much steam.

2

#### **Medium Speed Button**

Start the fan at medium speed.

This is ideal for ventilation during standard cooking operation.

3

#### **High Speed Button**

Start the fan at high speed.

This is ideal for ventilation when a high density of smoke or steam has been produced.



#### **Light Button**

Used for turning on/off the light.

## Maintenance

**Before cleaning switch the unit off and pull out the plug.**

### Regular Cleaning

Use a soft cloth moistened with hand-warm mildly soapy water or household cleaning detergent. Never use metal pads, chemical, abrasive material or a stiff brush to clean the unit.

### LED Light Replacement

Switch the unit off and unplug the appliance.



### CAUTION: LAMP UNIT MAY BE HOT!

Wait until the unit is cool before attempting to replace the LED lamps. Make sure the unit is powered off and **UNPLUGGED**.

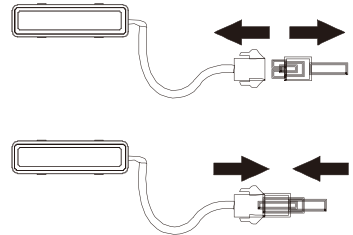
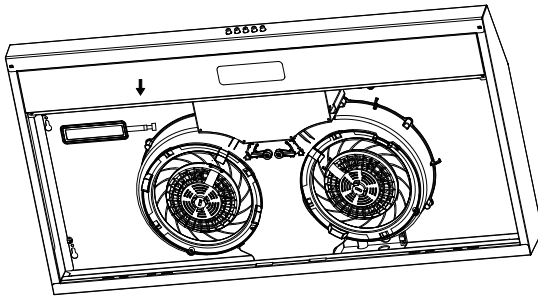

### Filter replacement

Clean the filters once a month by hand or in a dishwasher (30 °C).

Do not use any acrid or corrosive detergents. Do not use any abrasive detergents! Do not use any alkaline dishwasher-detergents! (pH more than 7). Do not put the filter in the dishwasher together with tableware.

Filters which are blocked with food debris do not carry a guarantee. Dry the filters properly before you reinstall them.

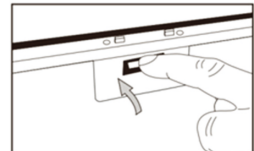
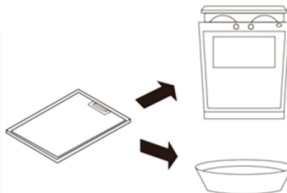
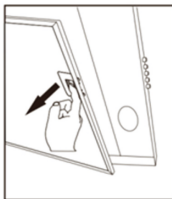

**Carbon filter life time:**

Defy recommends replacing the carbon filter every 3 months.

Please note, according to conditions in the kitchen the life span of the carbon filter might be longer or shorter than 3 months.

**Installation:**

Fit the carbon filter into the unit and turn it in as per the below diagram. Repeat the process for the opposite side.



**3 MONTHS**

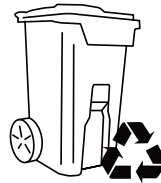
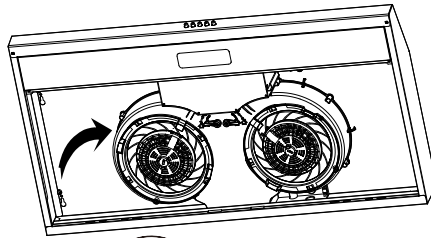
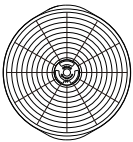

**Important:**

- 1. Make sure that the filter is securely locked in place to prevent it from coming loose and causing abnormal noise and becoming a safety risk.
- 2. Using the carbon filter reduces the air flow of the cooker hood.

<b>Technical specifications</b>		
Model		DCH90B/DCH90SS
Voltage/Frequency	V/Hz	220-240V~, 50/ 60Hz
Rated Input Power	W	122
Lamp Power	W	2
Product Dimension	L*W*H mm	895*480*100
N.W	KG	7.8

<b>Troubleshooting</b>		
<b>Fault</b>	<b>Cause</b>	<b>Solution</b>
Light on but fan does not work	The fan blade is jammed	Switch off the unit. Contact the customer care line. Repairs are to be done by qualified service personnel only
	The motor is damaged	
Both light and fan do not work	Light is burnt out	Replace the LED light with correct rating
	Power cord is loose	Plug into the power supply again
Heavy vibrations coming from the unit	The fan blade is damaged	Switch off the unit. Contact the customer care line. Repairs are to be done by qualified service personnel only
	The fan motor is not fixed tightly	Switch off the unit. Contact the customer care line. Repairs are to be done by qualified service personnel only
	The unit is not hung properly on the bracket	Take down the unit and check whether the bracket is in its proper location
Suction performance not good	Too far a distance between the unit and the cooktop	Readjust the distance to between 650-750mm

1. While unpacking, the packaging materials (polythene bags, polystyrene pieces, etc.) should be kept away from children.  
**CHOKING HAZARD!**
2. Old and unused appliances must be sent for disposal to the responsible recycling centre. Never expose to open flames.
3. Before you dispose of an old appliance, render it inoperative. Unplug the appliance and cut off the entire power cord. Dispose of the power cord and the plug immediately,
4. Dispose of any paper and cardboard into the corresponding containers.
5. Dispose of any plastics into the corresponding containers.
6. If suitable containers are not available at your residential area, dispose of these materials at a suitable municipal collection point for waste-recycling.
7. Receive more detailed information from your retailer or your municipal facilities.



Materials marked with the above symbol are recyclable.

Please contact your local authorities to receive further information.

## **Defy customer care call centre**

If you have followed the instructions and still have a problem or have any service or spares queries, please contact the customer care line by sending an email to **service@defy.co.za** or by calling **0861 00 3339**. They will be able to advise you on any aspect of the appliance.

## **Defy Sub-Saharan Africa Branch contact details**

### **ZAMBIA: SOUTHGATE INVESTMENTS LTD**

Plot 1606, Sheki Sheki Road  
P.O. Box 33681  
Lusaka, 10101, Zambia  
Tel: +260 0211 242332/3  
Fax: +260 0211 242933  
defyservicecenter@outlook.com

### **NAMIBIA: ATLANTIC DISTRIBUTORS (PTY) LTD**

10 Tienie Louw Street, Northern Industrial Area  
P.O. Box 21158, Windhoek, Namibia  
Tel: (061) 216162  
Fax: (061) 216134  
atlantic@mweb.com.na

### **ZIMBABWE: TRADE COM AFRICA**

Trade Com Africa, 183 Loreley Crescent  
Msasa, Harare, Zimbabwe  
Tel: +00263 773 438001  
servicecentre@tradecomafrika.com

### **BOTSWANA: RAY MORGAN AGENCIES**

RMA Service Centre, Plot 48, East Gate  
Gaborone International Commerce Park  
Kgale View, Gaborone  
Botswana  
Tel: +267 390 3996 / 390 3912  
Fax: +267 318 7376  
Cell: +267 7134 6539  
service@rma.co.bw

### **SWAZILAND: LYNDS DISTRIBUTORS**

P.O Box 716, Mbabane, Swaziland, H100  
Tel: (00268) 2515 4310/8  
Fax: (00268) 2518 4318  
workshop@hoageys.co.sz

### **MOZAMBIQUE: COOL WORLD. LDA**

Rua da Resistencia No. 97B R/C  
Cell: +258 84 44 61 234  
mdwholesale@mweb.co.za  
Nosso Show Room  
Av: da Industrias, Parcela No.735 \* 735A  
Machava, Maputo



## Warranty

This certificate is issued by DEFY APPLIANCES (PTY) LTD manufacturers of Defy and Ocean products, hereinafter the Company, to the original purchaser only, of the appliance described on the certificate and shall constitute the only warranty given in respect of this appliance.

The Company warrants to the original purchaser that for a period of TWO YEARS from date of purchase the appliance is free from defect under normal domestic use, both in workmanship and material, subject to the following conditions.

1. Repair or replacement of any part of this appliance, found by the Company to be defective, shall be at the election of the Company. The Company reserves the right to effect such service through any of its Service Divisions or Authorised Service Dealers. The cost of such service shall be borne by the Company in full, provided that the appliance is located no further than 50 km from a Company Service Centre or an Authorised Service Dealer. Where the appliance is located beyond the 50 km radius, the purchaser shall be liable for the standard travelling charges, as determined by the Company.  
CARRY IN SERVICE Microwave ovens, Compact cookers and small appliances are repaired in our service centres and are not collected from the customers home. Faulty units should be delivered to the purchasing dealer or to the nearest Company Service Centre for warranty repairs.
2. Cracked, rusted or corroded solid plates, vitreous enamelware, rust, cosmetic wear or cosmetic/external damage to products/components/fuses and lamps are specifically excluded from these warranties. It is an express condition of these warranties that the purchaser takes due care and attention in the use and maintenance of the appliance. Abuse, misuse in conflict with operating instructions, connection to incorrect voltages and subjection to commercial use shall release the Company from its obligations.
3. This warranty shall become void and cease to operate if the appliance is dismantled by, or any repairs to the appliance are effected by any persons not duly authorised by the Company, or if substitute parts not approved by the Company are used in the appliance, or if the serial number of the appliance is removed.
4. The Company shall not be responsible for damages resulting from fire, flood, civil disturbances or any Act of God. The Company shall not, in terms of these warranties be responsible nor held liable for any consequential loss or damage of any kind caused by or due to the failure or malfunction of the appliance. The Company shall not be responsible for damages caused by insect and/or animal infestation.
5. The Company shall not be responsible for transportation or other costs other than those incurred within the provisions of Point 1 of this Certificate.
6. **For warranties in the Republic of South Africa and Sub-Saharan Africa, please contact the customer care line. Please refer to the previous page for South African and Sub-Saharan African contact details.**
7. Where service is requested under warranty and no fault or defect can be found by the Company, all costs incurred will be for the purchaser's account.
8. This Certificate as well as your invoice will serve as proof of purchase. For the purpose of warranty, it will be essential to produce this Certificate and invoice. Failure to do so, will render the purchaser liable for service costs.

**KEEP THIS CERTIFICATE AND SALES INVOICE AS PROOF OF PURCHASE FOR WARRANTY PURPOSES.**





